



**COVER FOR FITTING
DIRECTIONAL CONTROL VALVE
Model : CVC*DE**

Ref. No. D 03428
Release 10 / 2015
ENGINEERING - 1 of 3

A Polyhydron Group Company

Description

The Covers **CVC*DE** are designed to hold Polyhydron make 2 port slip-in cartridge valves model **CV***** in the cavities machined as per ISO 7368, and control opening and closing of the cartridge valve by electrical signal.

Uses Solenoid operated directional control valve having interface conforming to ISO 4401-03-02 for actuation.

Normally used for directional control function of the cartridge.

Configurations available are as shown in the hydraulic symbols below.

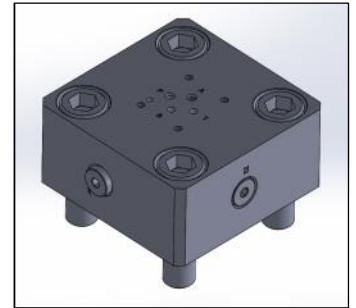

Hydraulic symbol

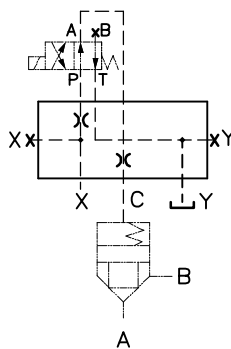

CVC*DEA***

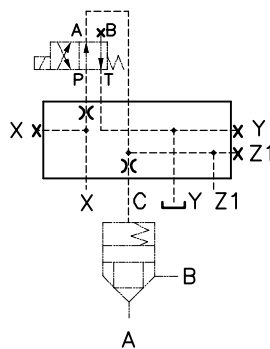

CVC*DEA-AZ1**

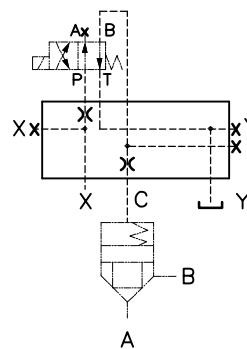

CVC*DEB***

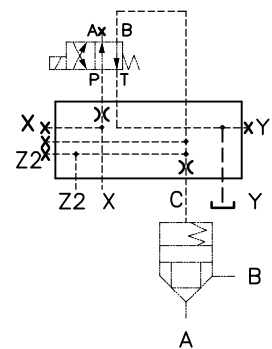

CVC*DEB-BZ2**

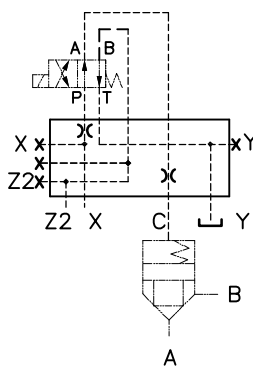

CVC*DEA-BZ2**

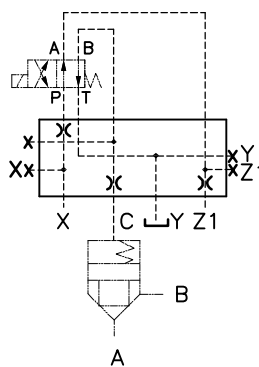

CVC*DEB-AZ1**

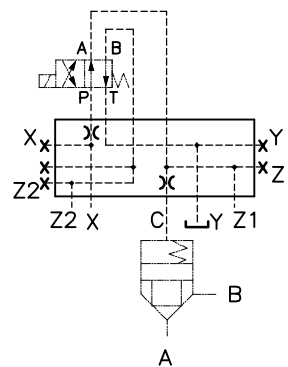

CVC*DEA-AZ1-BZ2**

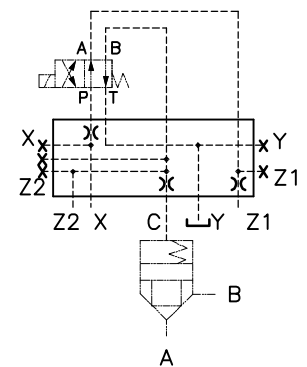

CVC*DEB-AZ1-BZ2**



Technical specifications

Mounting interface	:	As per ISO 7368
Working pressure	:	350 bar.
Hydraulic medium	:	Mineral oil.
Temperature range	:	-20°C to + 80°C.
Viscosity range	:	10 cSt to 380 cSt.
Fluid cleanliness required	:	ISO 4406 20/18/15 or better.

Unit dimensions

Dimensions in mm.

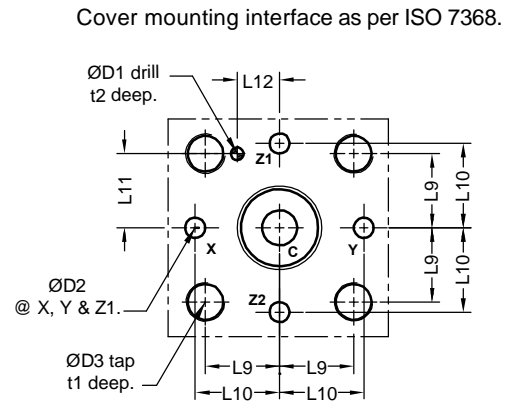
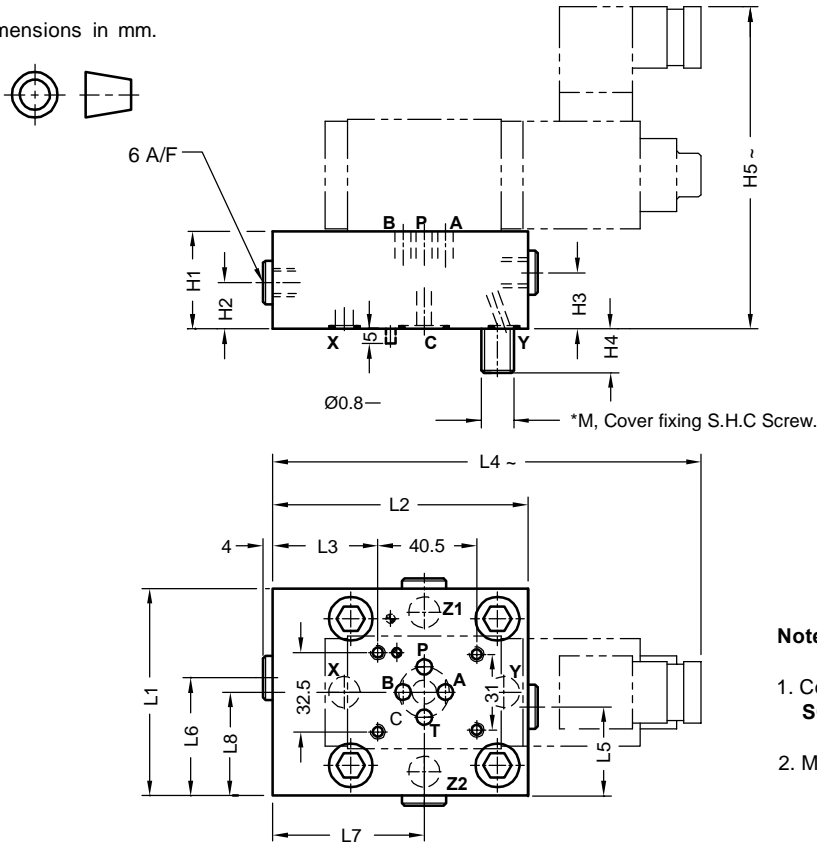

Notes:

1. Cover fixing S.H.C Screws are **OUT OF SCOPE OF SUPPLY.**
2. Mounting interface for Soln. D.C.V as per ISO 4401-03-02.

Size	Mass Kg. approx	L1	L2	L3	L4	L5	L6	L7	L8	L9	L10	L11	L12	ØD1	ØD2 max	ØD3	t1	t2	H1	H2	H3	H4	H5	*M. 4 nos. Cover fixing S.H.C. Screw (Class 12.9)	Tightening Torque.
16	2.0	65	80	14.5	137	27	37.5	33.5	32.5	23	25	23	10.5	4	4	M8	14	10	50	13	20	12	155	M8 x 40 Long	39 Nm
25	2.2	85	85	23.5	146	35.5	49.5	42.5	42.5	29	33	29	16	6	6	M12	20	10	40	18	18	18	145	M12 x 45 Long	135 Nm
32	4.1	102	102	32	154	43.5	58.5	51	51	35	41	35	17	6	8	M16	26	10	50	24	24	24	155	M16 x 55 Long	330 Nm
40	7.4	125	125	43.5	166	56.5	69.5	62.5	62.5	42.5	50	42.5	23	6	10	M20	33	10	60	30	30	30	165	M20 x 70 Long	650 Nm



Ordering code

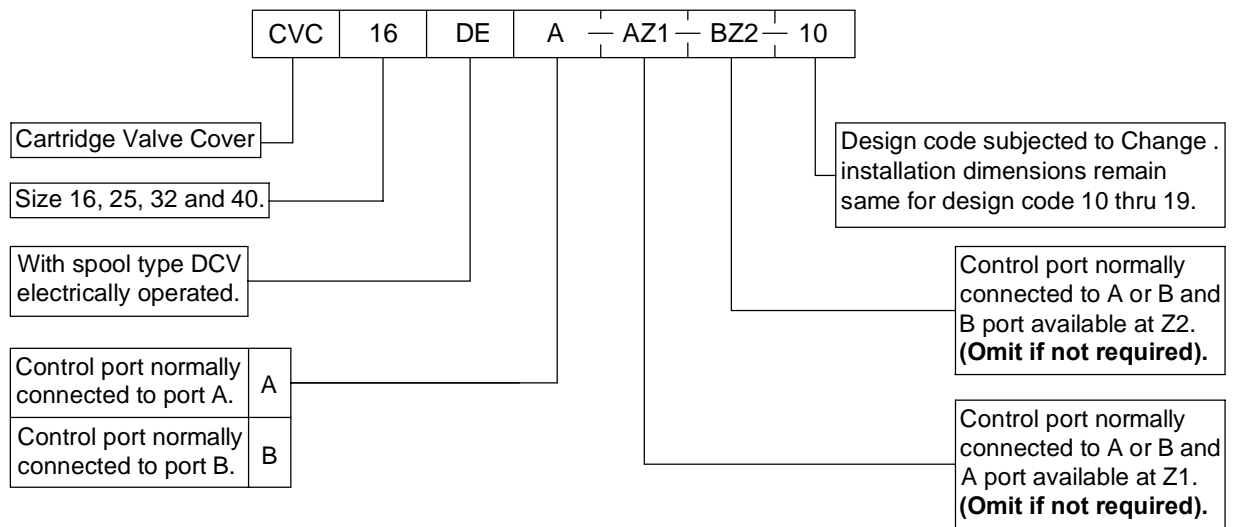

Note : Solenoid (refer spool type) to be ordered seperately.

