

Manually Operated Directional Valves

These valves may be used to manually shift the spool position and change the direction of oil flow.

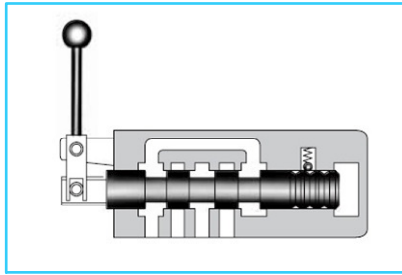
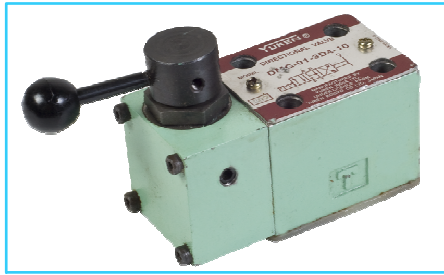

Specifications

Model Numbers	Maximum Flow L/min.				Max. Operating Pressure Kgf/cm ²	Max. T-line Back Pressure Kgf/cm ²	Mass Kg
	70 Kgf/cm ²	140 Kgf/cm ²	210 Kgf/cm ²	315 Kgf/cm ²			
DMG-01-3C※-10	35	35	35	--	250	140 ^{*2}	1.8
DMG-01-3D※-10							
DMG-01-2D※-10							
DMG-01-2B※-10							
DMG-03-3C※-50	100 ^{*1}	100 ^{*1}	100 ^{*1}	--	250	160 ^{*3}	4.0
DMG-03-3D※-50	100	100	100				
DMG-03-2D※-50							
DMG-03-2B※-50	100 ^{*1}	100 ^{*1}	100 ^{*1}	--			
DMG-06-3C※-50	500	500	500	500	315	210 ^{*3}	11.5
DMG-06-3D※-50							
DMG-06-2D※-50							
DMG-06-2B※-50	420	300	250	200			12

Note: Max. flow means the limited flow which does not affect the normal function (changeover) of the valve.

- 1 Varies depending of the spool type. For the detail, see the “List of standard models and max. flow” for DSG-03 Series Solenoid Operated Directional Valves (EIC-E-1002, Page 362 or 363 at 50 Hz rated voltage.)
- 2 Lever operating torque varies depending on the T-Line back pressure. See the figure below.
- 3 If the T-Line back pressure exceeds 70 Kgf/cm², directly connect the drain port to the reservoir.

DMG-01 Lever Operating Torque

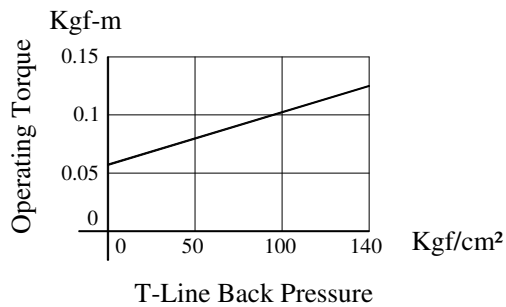

Model Number Designation

F-	DM	G	-03	-2	B	2	A	-50
Special seals	Series Number	Type of Connections	Valve Size	Number of Valve Positions	Spool Spring Arrangement	Spool Type	Special Two Position Valve	Design Number
F: Special seals for Phosphate Ester Type Fluids (Omit if not required)	DM: Manually Operated Directional Valve	G: Sub-Plate Mounting	01	3	C: Spring Centered	2, 3, 4, 40, 5, 6, 60,	A, B (Omit if not required)	10
			03					50
			06	2	D: No-Spring Detented B: Spring Offset	7, 8, 9, 10, 11, 12	50	
See the table for combinations.								

* Refer to column “valves with centre position and one offset position” (Special 2-position valves) on Page 396.

List of Spool Type

Spool Type	DMG-01		DMG-03		DMG-06	
	3C 3D	2D 2B	3C 3D	2D 2B	3C 3D	2D 2B
	O	O	O	O	O	O
	O	O	O	O	-	O
	O	-	O	-	O	O
	O	-	O	-	O	O
	O	-	-	-	-	-
	-	-	-	-	O	-
	-	-	-	-	O	-
	O	-	O	-	O	-
	O	O	-	-	O	O
	O	O	O	-	O	-
	O	-	O	-	O	-
	O	-	O	-	O	-
	O	-	O	-	O	-
	O	-	O	-	O	-
	O	-	O	-	O	-

Graphic Symbol

- **Spring Centred Models (3C※)**

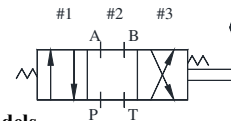

- **No-Spring Detented Models (3D※)**

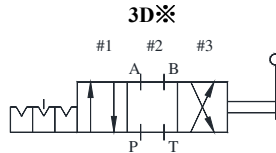

2D※

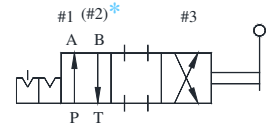

- **Spring Offset Models (2B※)**

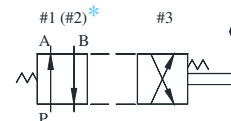

* Position #2 is applied for model DMG-01-2B※ and DMG-03-2B※/2D※

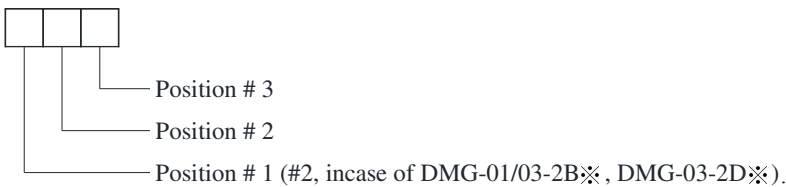

Note : The O Mark indicate the spool type available for each type.

Valves with Centre position and One Offset Position (Special Two Position Valve)

In addition to the standard two position valves (2D※, 2B※), the following two types of two positions valves are available: Valves with centre position (#2) and position #1(2B※A, 2D※A), valves with centre position (#2) and position #3 (2B※B, 2D※B).

The O mark in the table below indicates the spool type available for each models.

Spring Offset Models

Valve Type	Graphic Symbols	Model	
		DMG-03	DMG-06
2B2A		O	O
2B3A		O	O
2B4A		—	O
2B40A		—	O
—	—	—	—
2B5A		—	O
2B6A		—	O
2B60A		—	O
2B7A		—	O
—	—	—	—
2B9A		—	O
2B10A		—	O
2B11A		—	O
2B12A		—	O

Valve Type	Graphic Symbols	Model		
		DMG-01	DMG-03	DMG-06
2B2B		O	O	O
2B3B		O	O	O
2B4B		O	O	O
2B40B		O	—	O
2B5B		O	—	—
		—	—	O
2B6B		—	—	O
2B60B		O	O	O
2B7B		O	—	O
2B8B		O	—	—
2B9B		O	—	O
2B10B		O	O	O
2B11B		O	—	O
2B12B		O	O	O

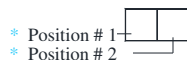
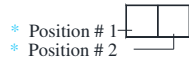

No-spring Detented Models

Valve Type	Graphic Symbols	Model
		DMG-06
2D2A		O
2D3A		O
2D4A		O
2D40A		O
—	—	—
2D5A		O
2D6A		O
		—
2D60A		O
		—
2D7A		O
2D8A		—
2D9A		O
2D10A		O
2D11A		O
2D12A		O

Valve Type	Graphic Symbols	Model	
		DMG-01	DMG-06
2D2B		O	O
2D3B		O	O
2D4B		O	O
2D40B		O	O
2D5B		O	—
		—	O
2D6B		—	O
		—	—
2D60B		O	O
		—	—
2D7B		O	O
2D8B		O	—
2D9B		O	O
2D10B		O	O
2D11B		O	O
2D12B		O	O

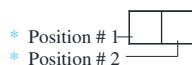
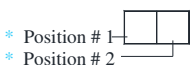

Note : Position number is determine with three position type (3C※ and 3D※) as the standard.

Sub-plate

Valve Model Numbers	Sub-plate Model Numbers	Thread Size	Approx. Mass Kg
DMG-01	DSGM-01-3080	1/8 BSP.F	0.8
	DSGM-01X-3080	1/4 BSP.F	0.8
DMG-03	DSGM-03-3080	3/8 BSP.F	3.0
	DSGM-03X-3080	1/2 BSP.F	3.0
	DSGM-03Y-3080	3/4 BSP.F	4.7
DMG-06	DSGM-06-3080	3/4 BSP.F	7.4
	DSGM-06X-3080	1 BSP.F	7.4

- Sub-plates are available. Specify sub-plate model from the table above. When sub-plates are not used, the mounting surface should have a good machined finish.
- Sharable with solenoid operated Directional Valves and Solenoid Controlled Pilot Operated Directional Valves. For dimensions, refer to the right table then see the corresponding pages.

- Sub-plate dimension appearing page

Sub-plate Model No.	Page
DSGM-01※	EIC-E-1001, Page-358
DSGM-03※	EIC-E-1002, Page-370
DSGM-06※	EIC-E-1003, Page-385

Mounting Bolts

Model Numbers	Socket Head Cap Screw	Qty.	Mounting Bolt Ordering Code
DMG-01	M5 x 45 Lg.	4	BKDMG-01-10
DMG-03	M6 x 35 Lg.	4	BKDMG-03-50
DMG-06	M12 x 60 Lg.	6	BKDMG-06-50

Instructions

- Avoid connecting the tank Port “T” to a line with possible surge pressure.

Pressure Drops

The pressure drop characteristics are based on the following conditions: viscosity of the fluid:35cSt
Specific Gravity: 0.850

- For any other viscosity, multiple the factors in the table below.

Viscosity	cSt	15	20	30	40	50	60	70	80	90	100
Factor		0.81	0.87	0.96	1.03	1.09	1.14	1.19	1.23	1.27	1.30

- For any other specific gravity (G'), the pressure drop (ΔP') may be obtained from the formula below.
ΔP' = ΔP G'/G where, ΔP is a value on the following chart and G is 0.850.

● **DMG-01**

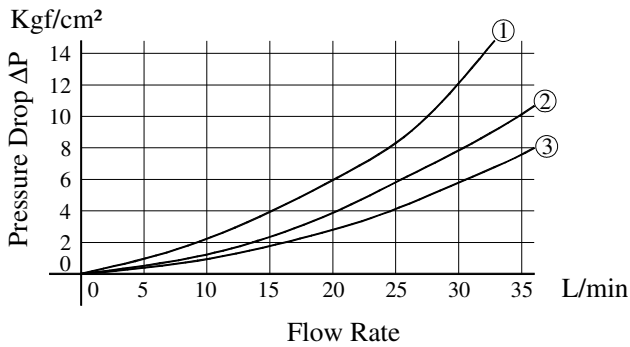

Valve Type				Pressure Drop Curve Number				
3C※	3D※	2D※	2B※	P→A	B→T	P→B	A→T	P→T
3C2	3D2	2D2		③	③	③	③	—
3C3	3D3	2D3		③	③	③	③	②
3C4	3D4			③	③	③	③	—
3C40	3D40			③	③	③	③	—
3C5	3D5			②	①	①	①	③
3C60	3D60			①	①	①	①	③
3C7	3D7	2D7		③	③	③	③	—
3C8	3D8	2D8		③	—	③	—	—
3C9	3D9			③	③	③	③	—
3C10	3D10			③	③	③	③	—
3C11	3D11			③	③	③	③	—
3C12	3D12			③	③	③	③	—
			2B2	②	②	③	③	—
			2B3	②	②	③	③	—
			2B8	③	—	③	—	—

● For **DMG-03**, **DMG-06**, refer to the table below then see the related page.

Model Number	Pressure Drop Characteristics	Page	Remarks
DMG-03	Same as DSG-03 Series Solenoid Operated Directional Valves (standard Type)	EIC-E-1002 Page 367	3D※ is same as 3C※
DMG-06	Same as Solenoid Controlled Pilot Operated Directional Valves (DSHG-06)	EIC-E-1003 Page 379	

How to change Lever Position

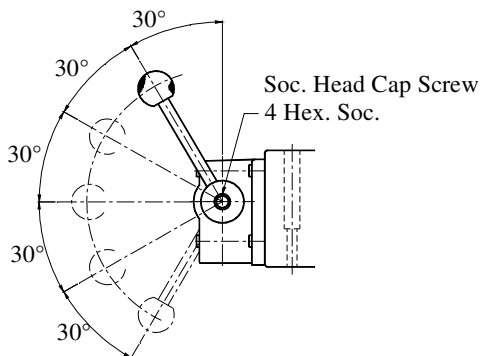

The lever position can be changed to any five positions as shown in the above sketch. For the lever position change, remove the Soc. Head Cap Screw and lever once, set the lever at the required position and tighten it with Soc. Head Cap Screw firmly.

● DMG-01-※※※※-10

Mounting Surface : ISO 4401-AB-03-4-A

DIMENSIONS IN MILLIMETRES

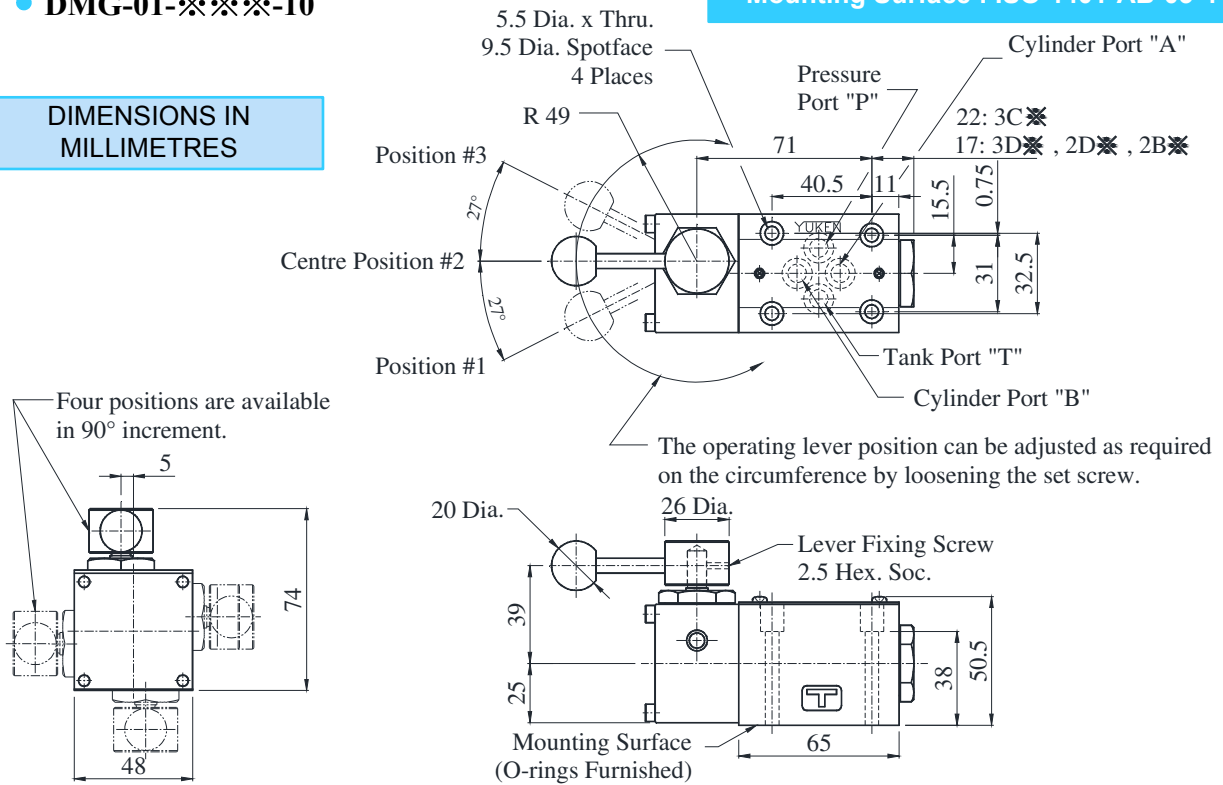

Note : For the valve mounting surface dimensions, see the dimensional drawing of the sharable sub-plate in page EIC-E-1001, Page-357

● DMG-03-※※※※-50

Mounting Surface : ISO 4401-AC-05-4-A

Finishing Dimensions of Flow Restrictor

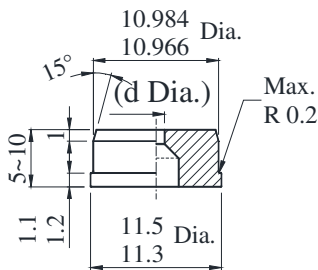

Orifice Dia. "d" should be determined by customer application.

