

Shut off Valve, Sub-plate mounting, Model : MHSLB



the right connection

Ref. No : H04058, Release Oct 2006 (Dimensions in mm)

Description

Seat type valve with replaceable cartridge.
Balanced poppet construction to reduce operating forces.

Can also be used for throttling the flow.

Provision for locking the spindle in any set position (for throttling purpose).

Sub - plate mounting construction (Factory standard).



Section

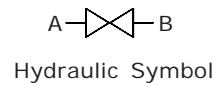
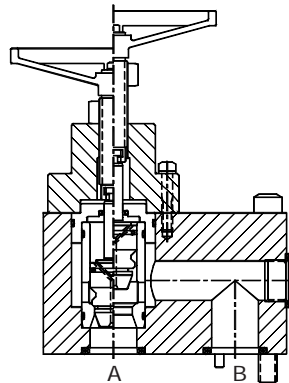

Unit Dimensions

Valve

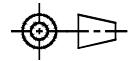

Model Code	Size	A	B	L1	L2	ØD	a	S
MHSLB40-2.0	40	173	180	183	344	190	62	46
MHSLB50-2.0	50	260	200	188	378	190	78	46
MHSLB63-2.0	63	275	240	219	449	275	160	55
MHSLB80-2.0	80	355	305	228	523	275	164	55

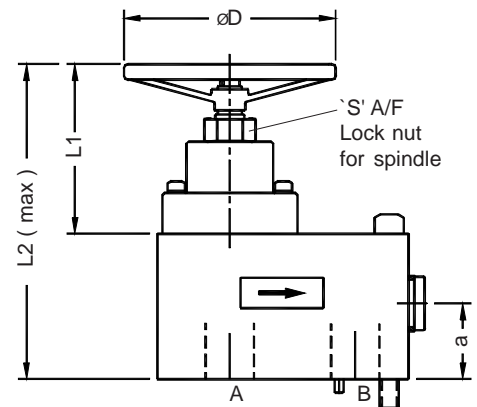

Model Code	Valve Fixing Screws (Grade)	Tightening Torque
MHSLB40-2.0	M16x2.0x150 Long, 6 nos (10.9)	240 Nm
MHSLB50-2.0	M20x2.5x180 Long, 6 nos (12.9)	488 Nm
MHSLB63-2.0	M20x2.5x190 Long, 8 nos (12.9)	650 Nm
MHSLB80-2.0	M24x3.0x200 Long, 8 nos (12.9)	1100 Nm

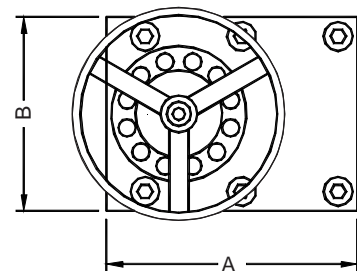

Shut off Valve, Sub-plate mounting, Model : MHSLB



the right connection

Ref. No : H04058, Release Oct 2006 (Dimensions in mm)

Interface - Factory standard

NG 40 and NG 50

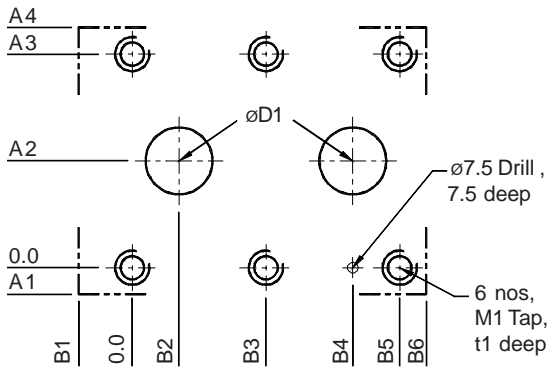

NG 63 and NG 80

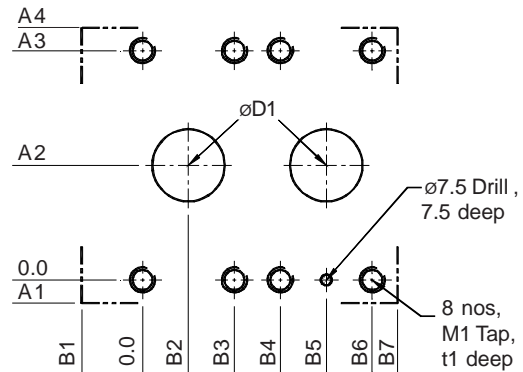

Model Code	ØD1	A1	A2	A3	A4	B1	B2	B3	B4	B5	B6	B7	M1	t1
MHSLB40-2.0	40	15.0	75	150	165	43	20	55	90	110	130	--	M16x2.0	24
MHSLB50-2.0	50	20.0	80	160	180	40	35	100	165	200	220	--	M20x2.5	30
MHSLB63-2.0	63	20.0	100	200	220	53	40	80	120	160	200	222	M20x2.5	30
MHSLB80-2.0	76	22.5	130	260	282.5	67	55	110	155	210	265	288	M24x3.0	37

Technical Specifications

- Construction Seat type valve with seals on poppet. Partially balanced.
- Mounting type Sub-plate mounting construction conforming to factory standard.
- Mounting position Optional
- Flow direction From port `A' to port `B'.
- Operating pressure 400 bar.
- Hydraulic medium Mineral oil.
- Viscosity range 10 cSt to 380 cSt.
- Fluid temperature range -20 °C to +70 °C.
- Fluid cleanliness requirement As per ISO 19/16 or better.
- Maximum flow handling capacity Refer graph.

Expected performance
With oil viscosity of 68 cSt

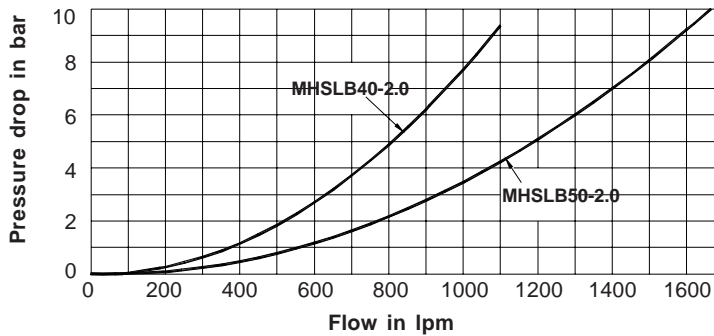

Ordering Code

